

# Navitect II

Detail:

- N1 dakgoot aansluiting
- N2 nok aansluiting
- N3 verticale overgang Navitect II naar pannen
- N4 verticale overgang pannen naar Navitect II
- N5 horizontale overgang pannen naar Navitect II
- N6 oplossingen woningscheidende wand
- N7 dakraam boven- en onderaansluiting
- N8 dakraam zijaansluiting
- N9 verticale aansluiting Navitect II

-  Isolatie
-  Baksteen of dakpan
-  Beton / kalkzandsteen
-  Doorgesneden hout
-  Zijaanzicht hout
-  Spaanplaat
-  Navitect systeem
-  Navitect PV-panelen

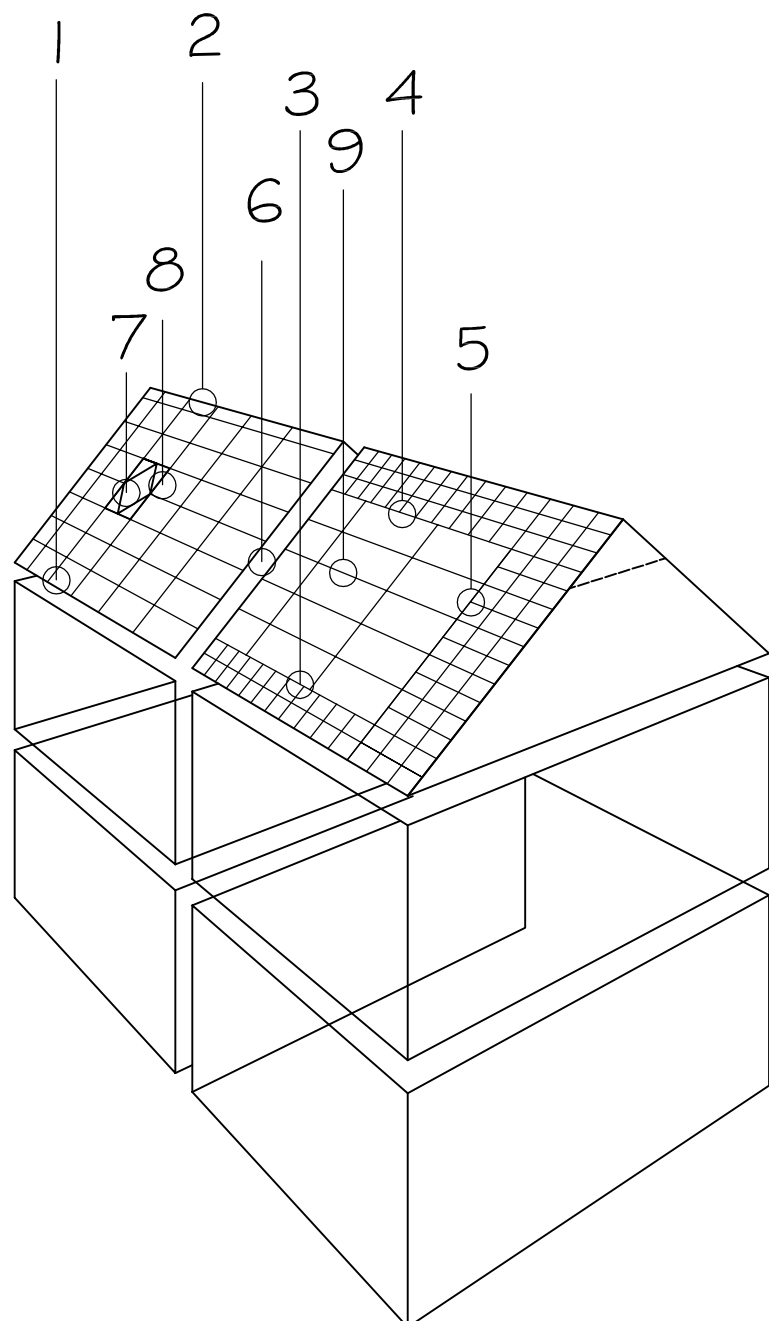

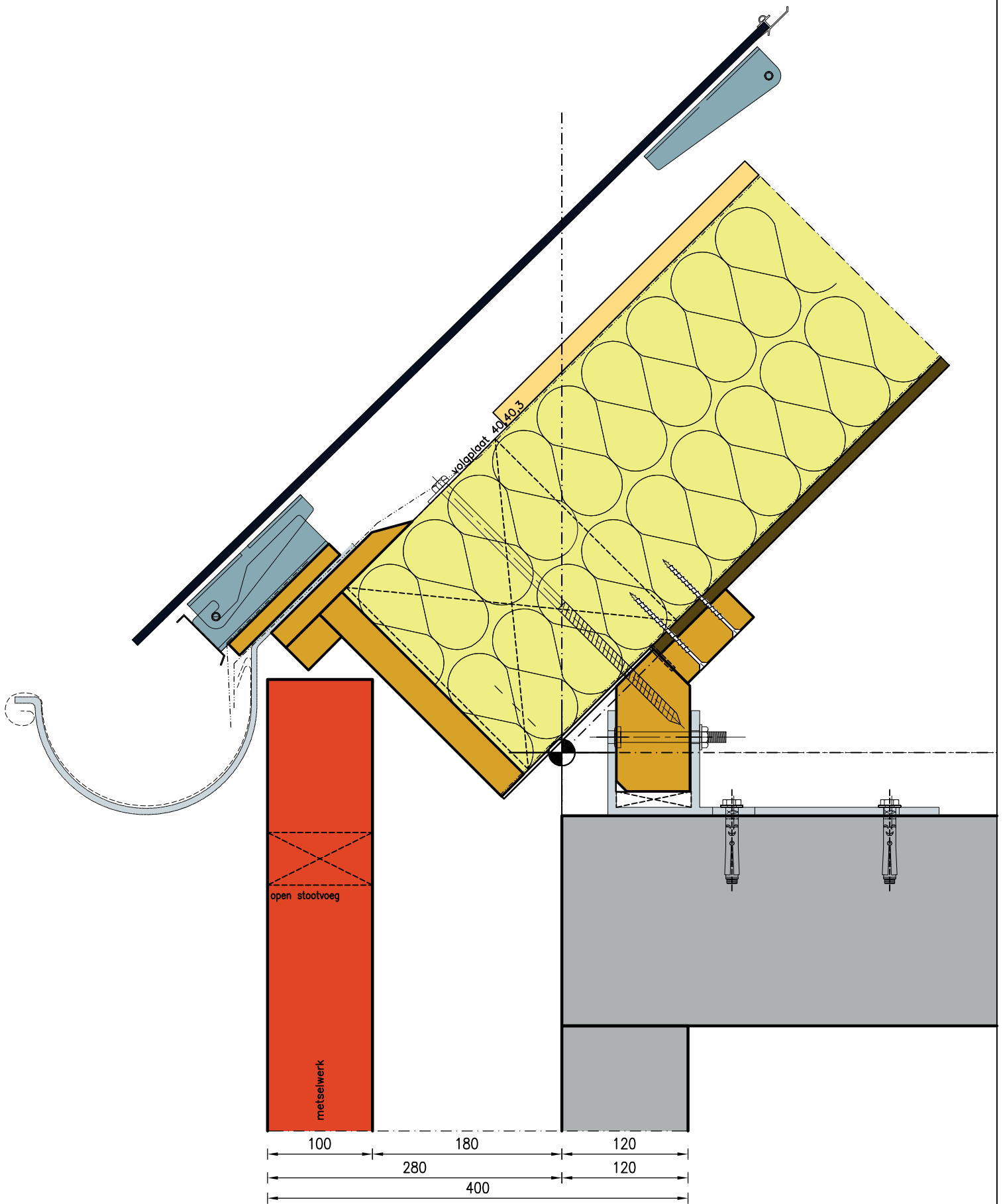

N1a dakgoot aansluiting

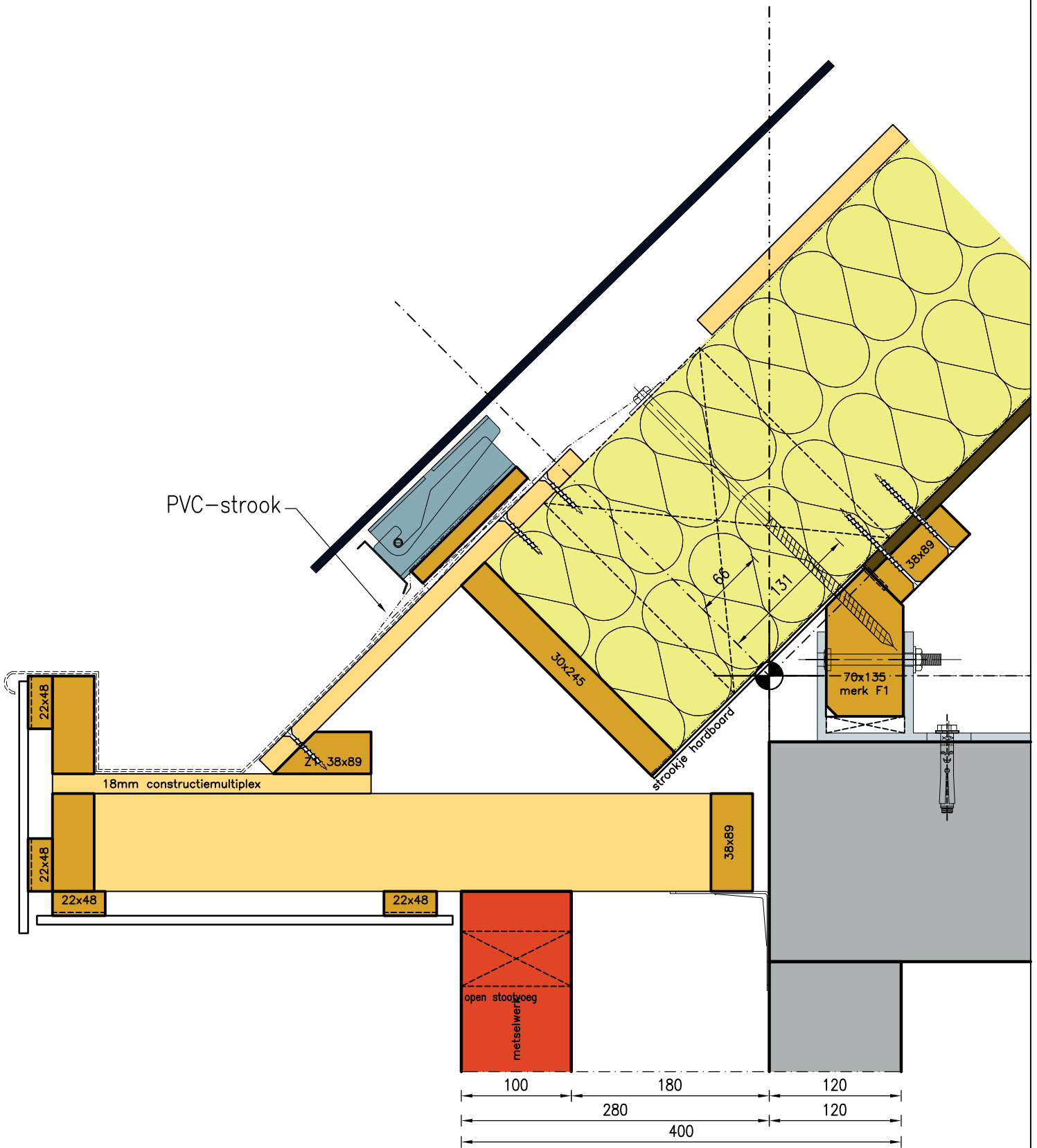

N1c dakgoot aansluiting

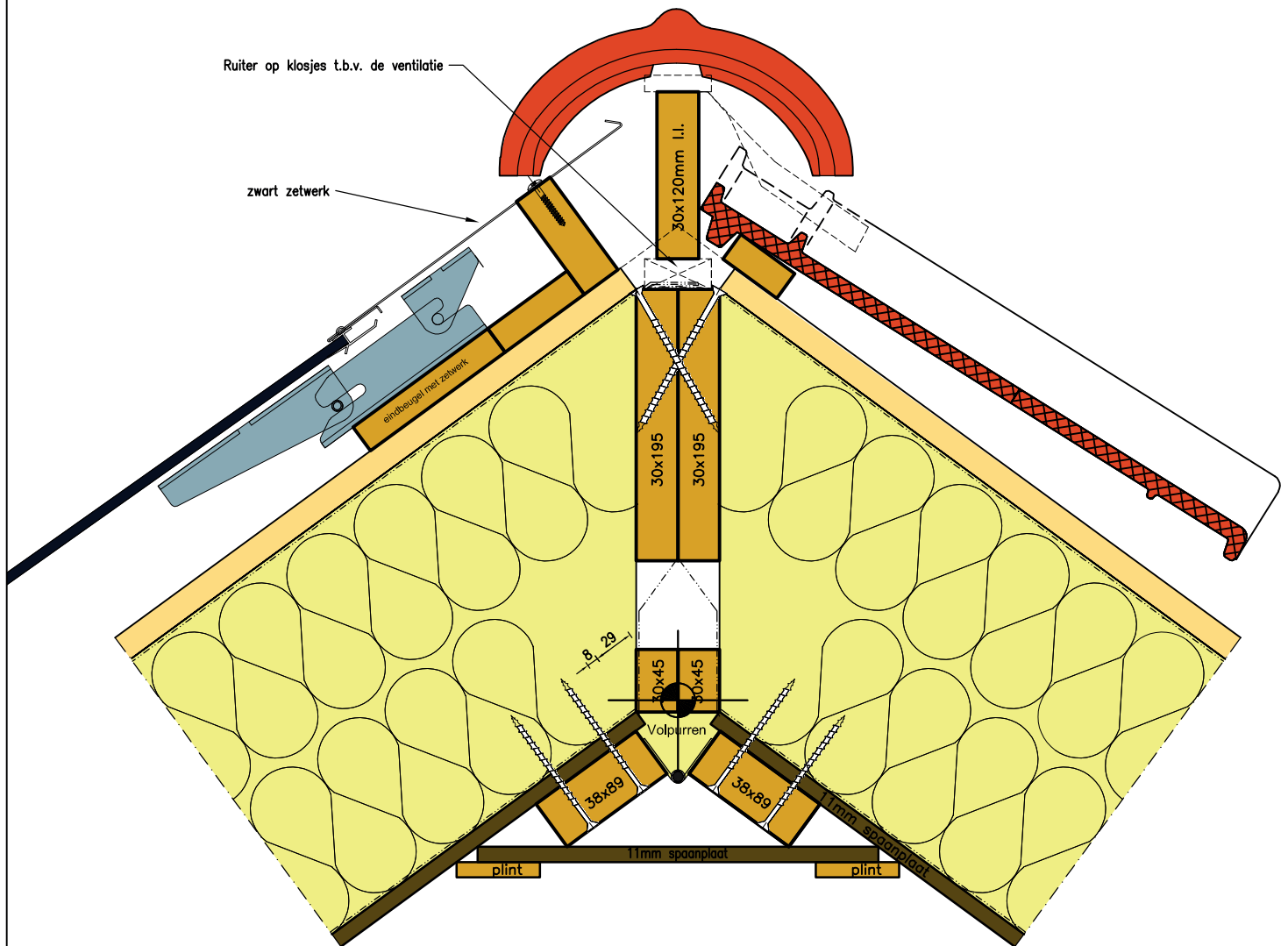

N2 nok aansluiting

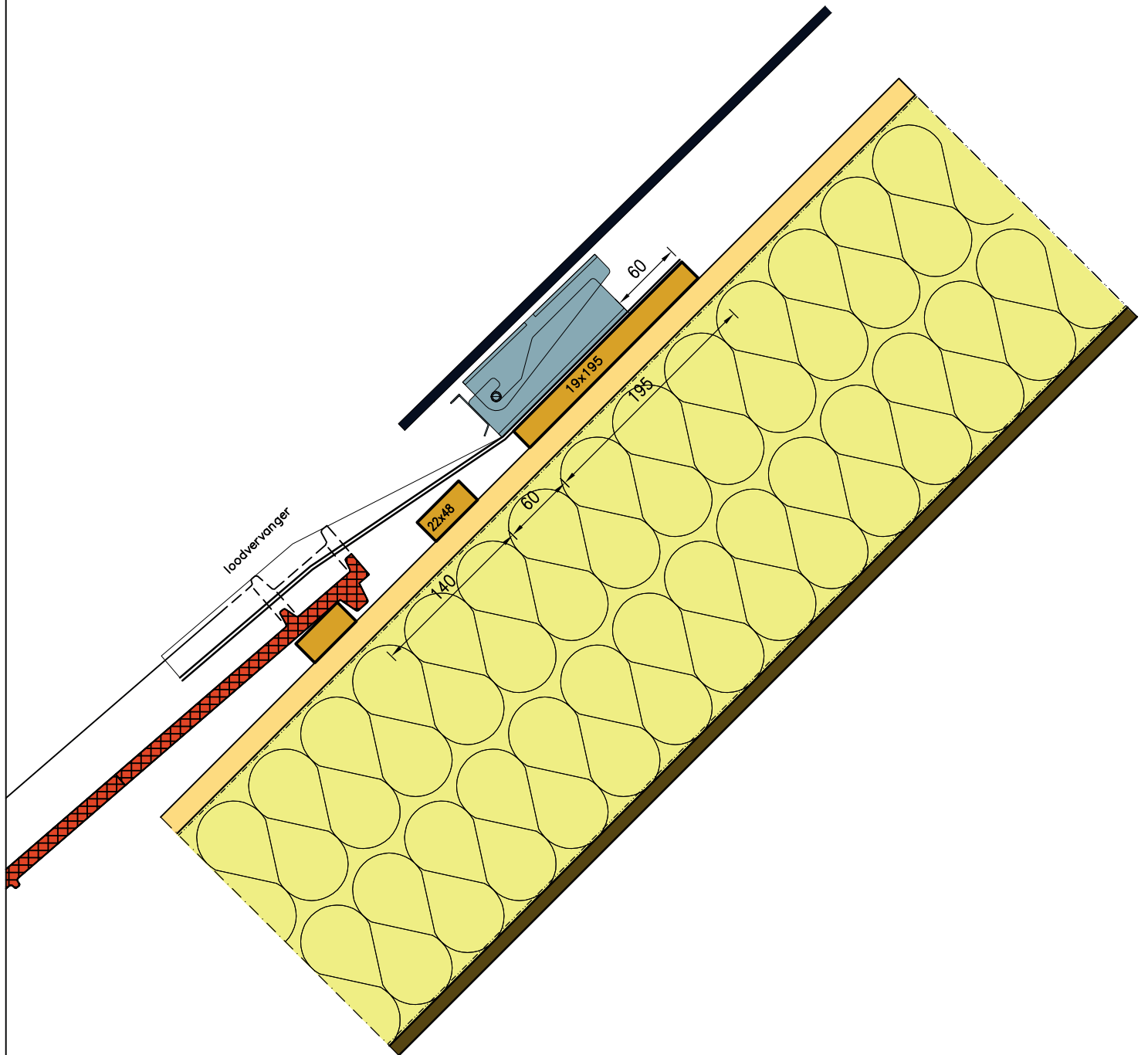

N3 verticale overgang Navitect II naar pannen

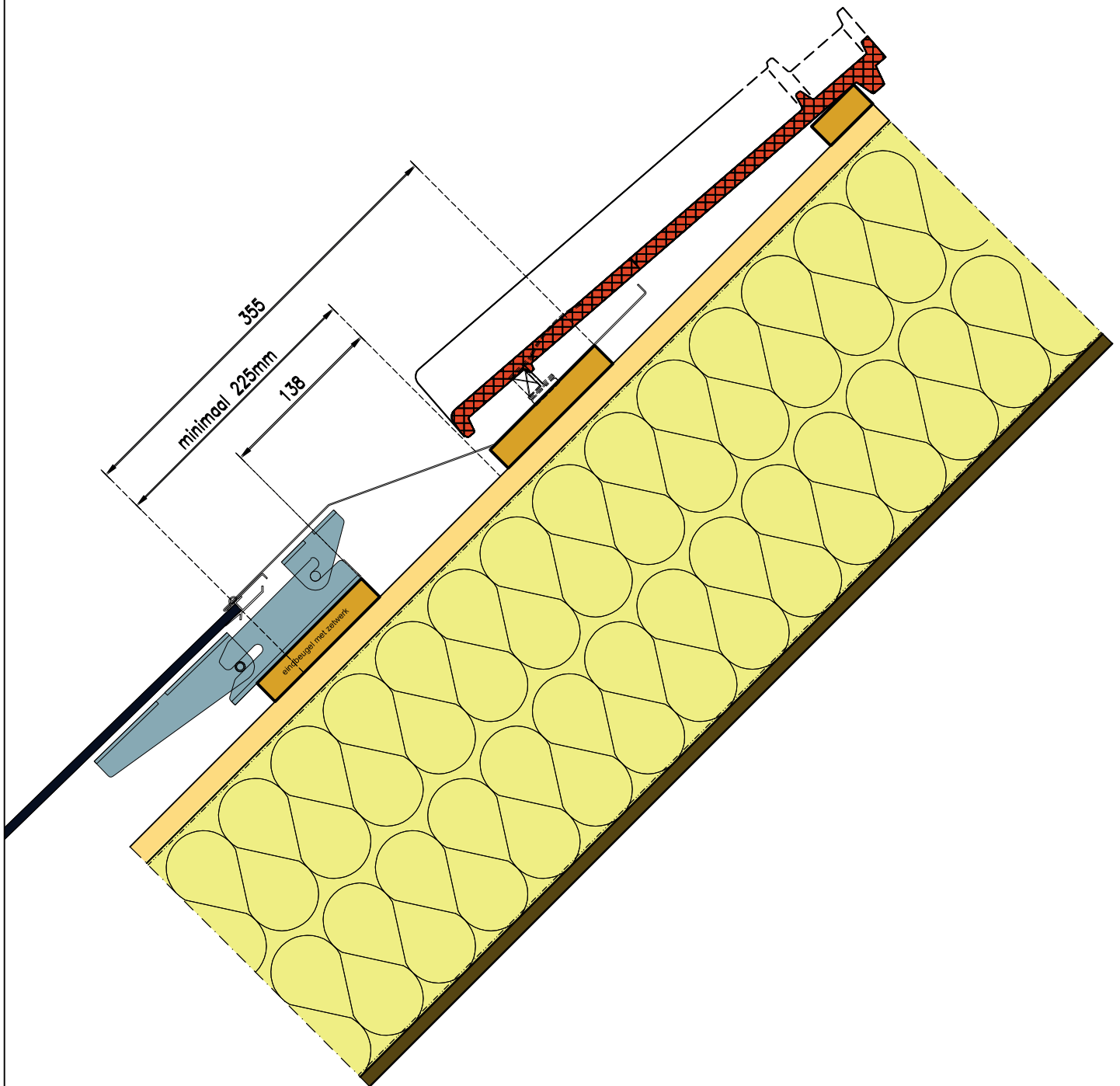

N4 verticale overgang pannen naar Navitect II

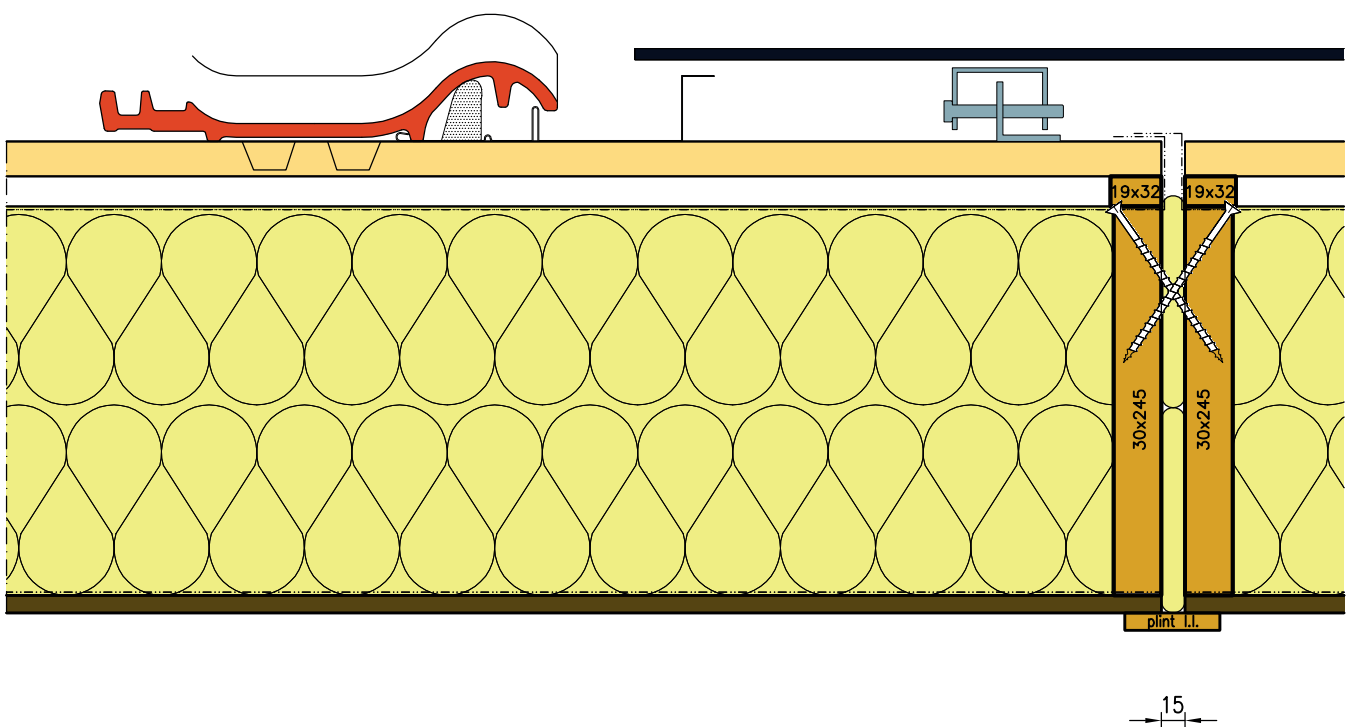

Elementnaad

N5 horizontale overgang pannen naar Navitect II

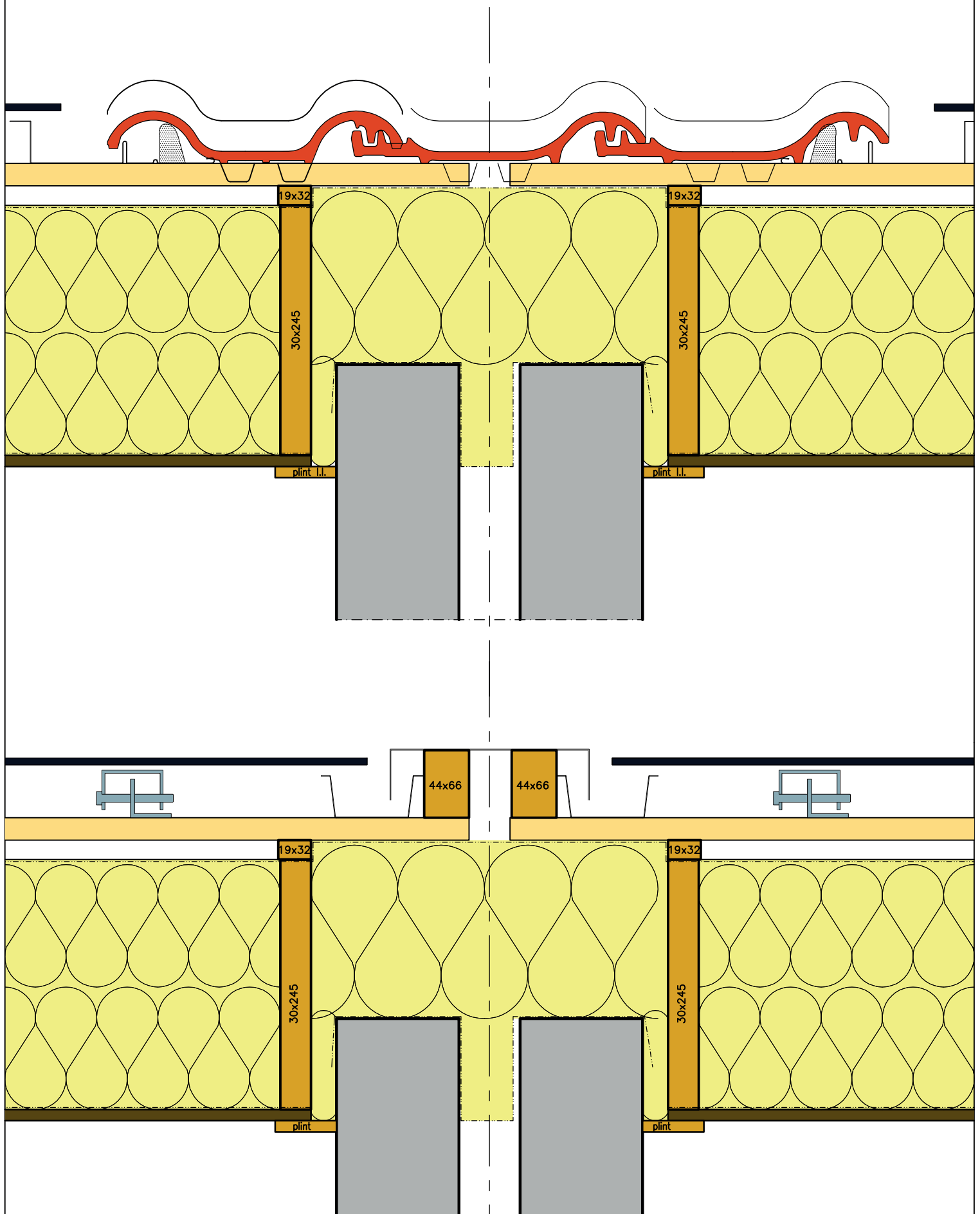

N6 oplossingen woningscheidende wand



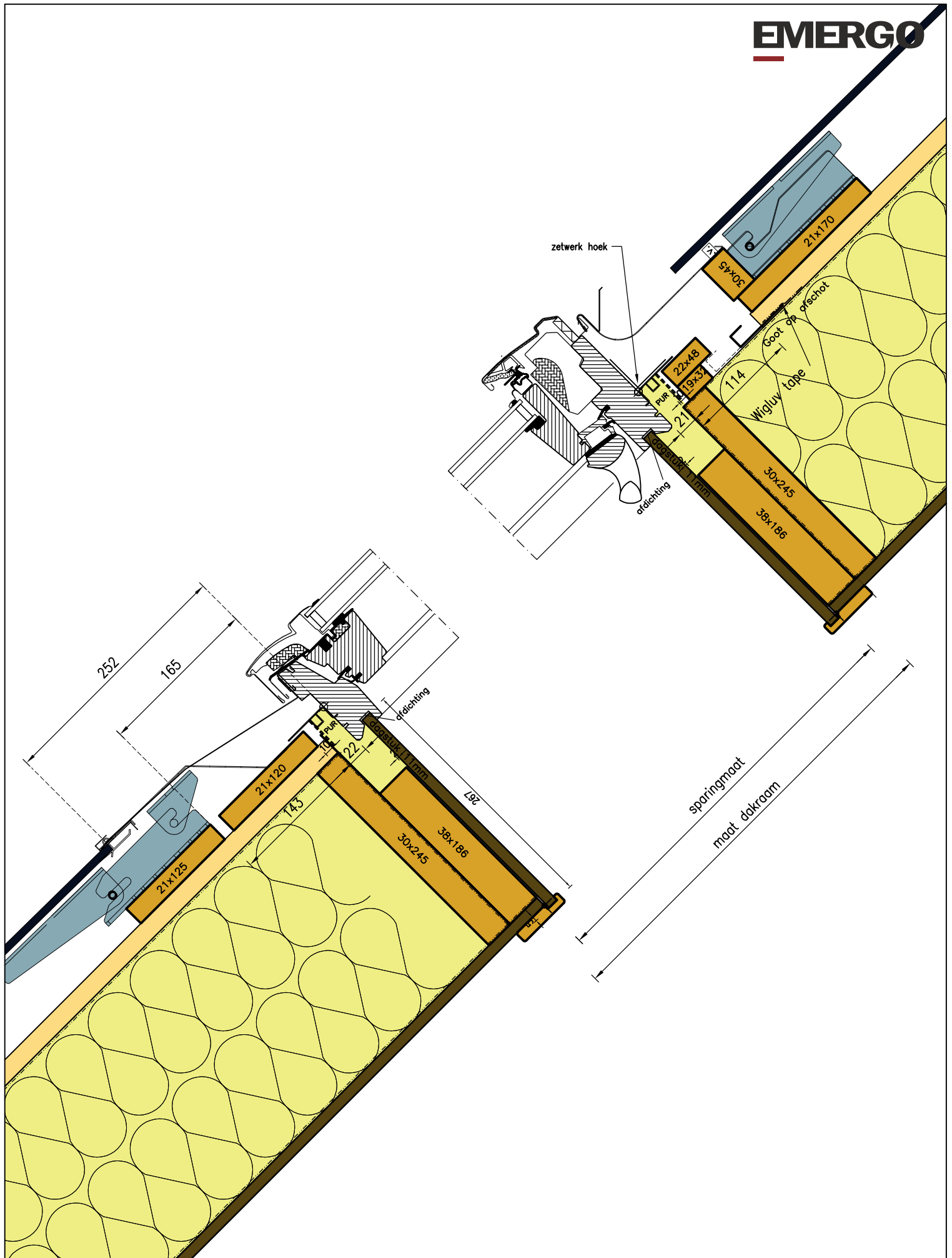

N7a dakraam boven- en onderaansluiting Navitect II

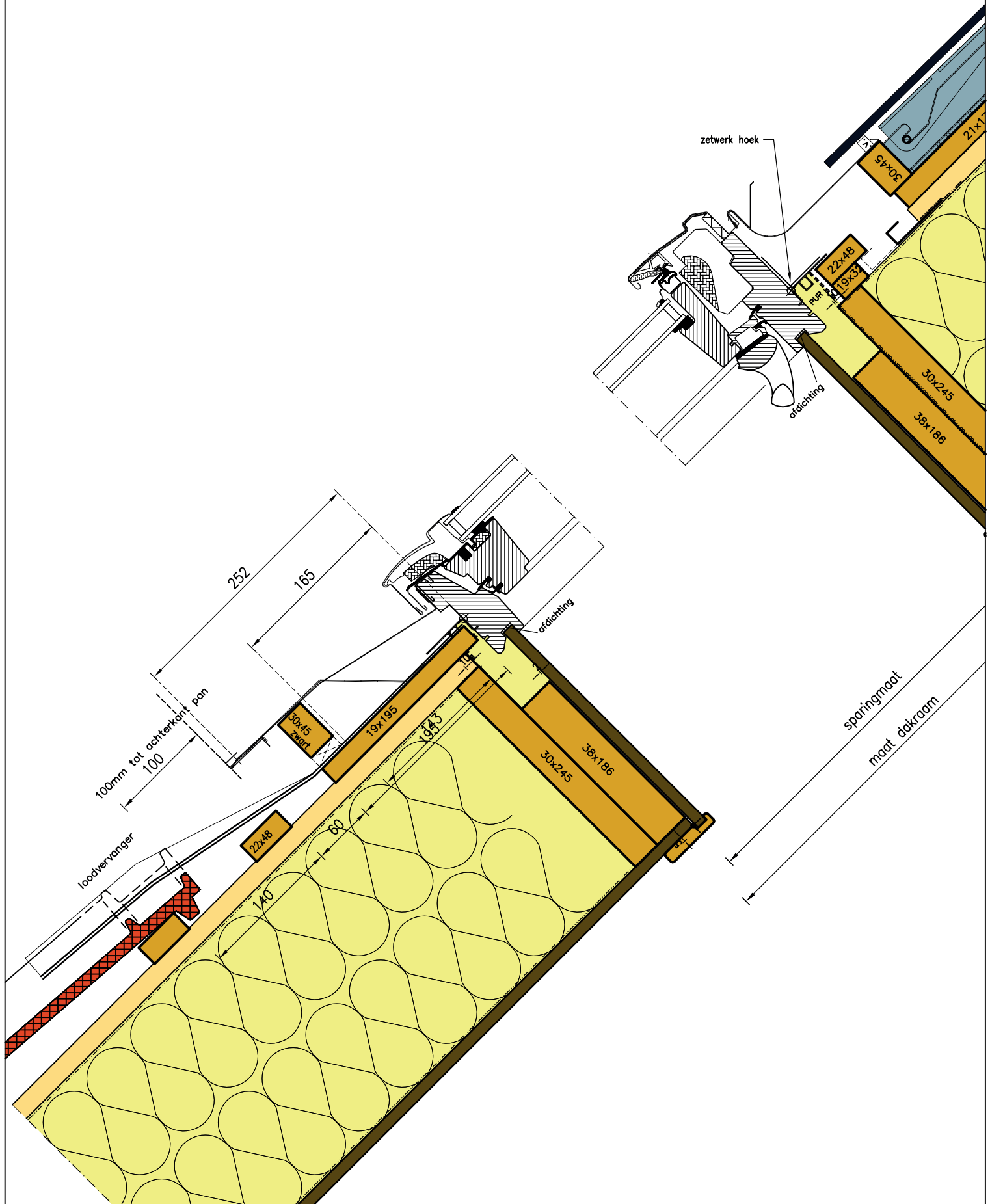

N7b dakraam onderaansluiting pannen

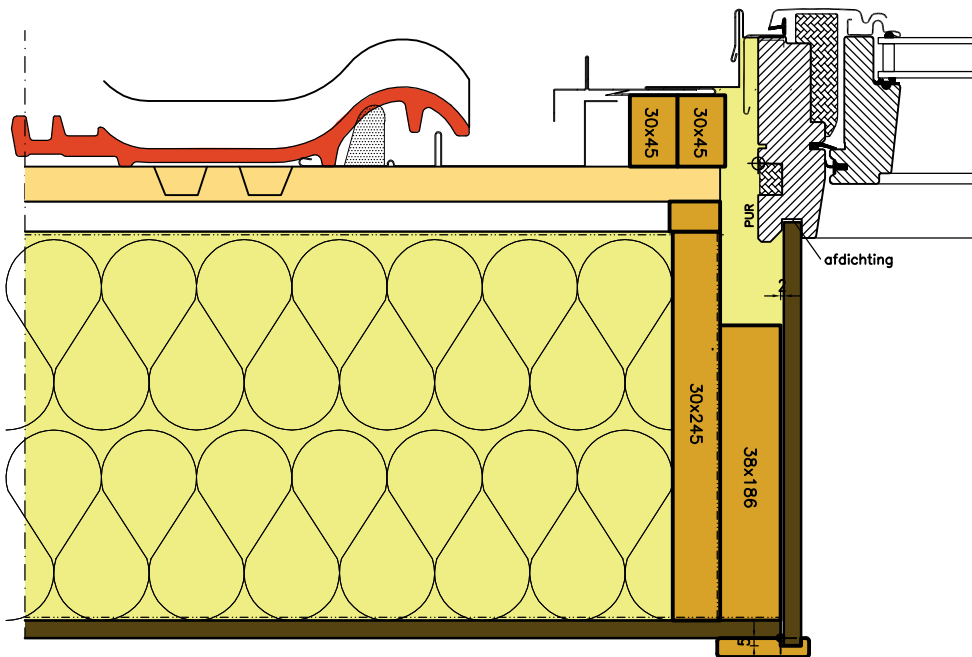
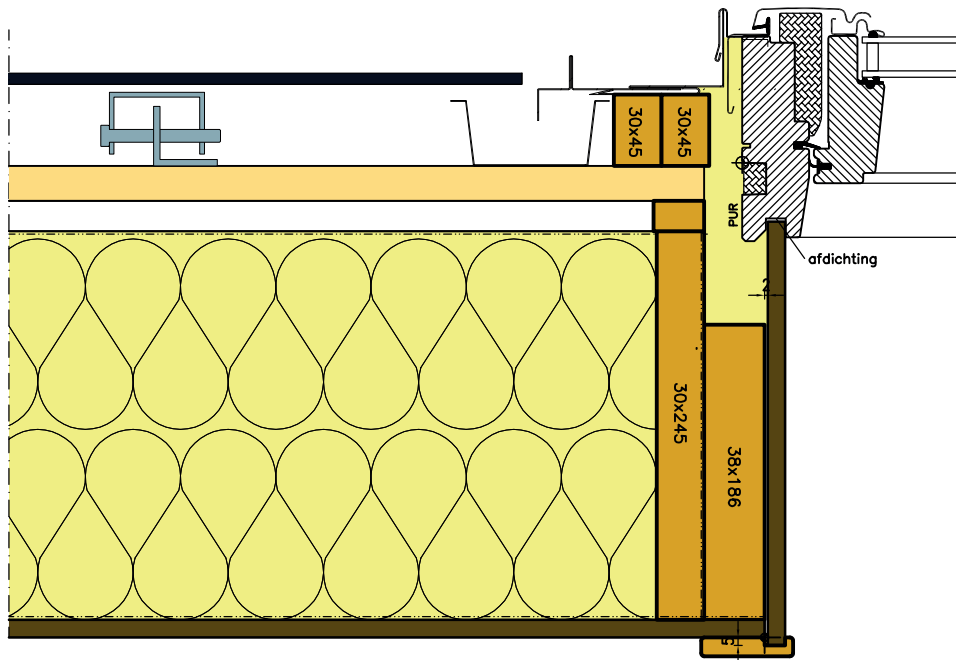

N8 dakraam zijaansluiting

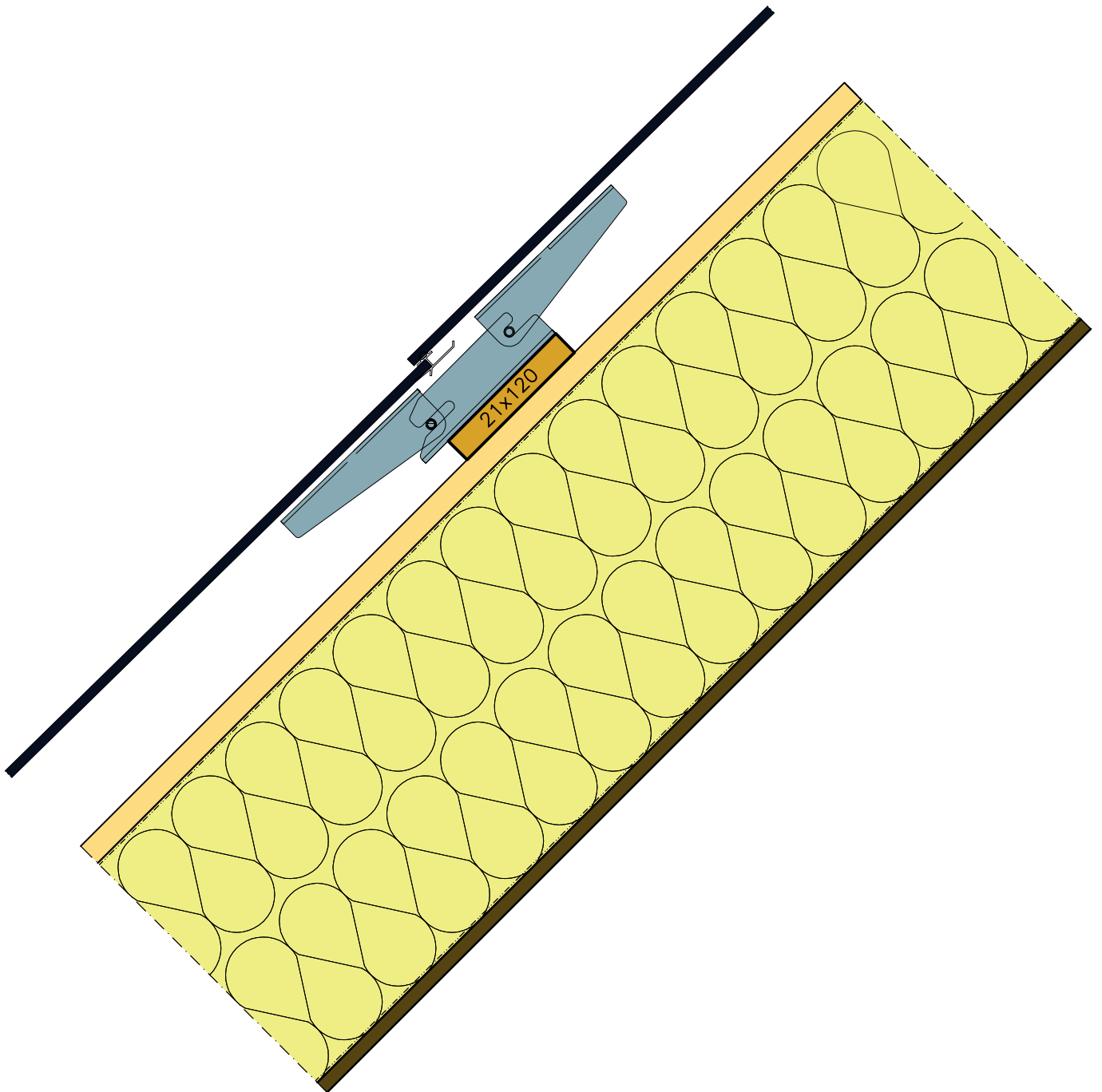

N9 verticale aansluiting Navitect II